

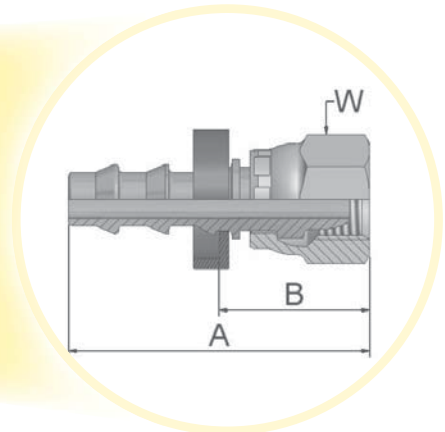



FF – Metru-Lok Swivel Female



Approved fitting series for hose types:

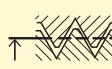

XXXX.XX.XX Part Number 	 Hose I.D.				 Thread metric	Tube O.D.	A	B	 W
	DN	Inch	Size	mm					
3FF82-6-4B	6	1/4	-4	6,3	M10x1	6	36	16	14
3FF82-8-4B	6	1/4	-4	6,3	M12x1	8	31	12	14
3FF82-10-6B	10	3/8	-6	9,5	M14x1	10	35	12	17
3FF82-12-6B	10	3/8	-6	9,5	M16x1	12	35	12	19
3FF82-14-8B	12	1/2	-8	12,7	M18x1	14	38	12	22
3FF82-16-8B	12	1/2	-8	12,7	M22x1,5	16	38	12	24
3FF82-18-10B	16	5/8	-10	15,9	M24x1,5	18	51	15	27
3FF82-22-12B	20	3/4	-12	19,1	M28x1,5	22	51	15	32

Material: Brass (B)





Information about standard products or non-standard products can be found in the current price list.
Dimensions shown may be changed at any time without prior notice.

AF – Male BSP Parallel Pipe – Rigid – Straight (with O-Ring Seal)



Approved fitting series for hose types:

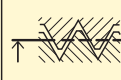

XXXX-XX-XX Part Number 	 Hose I.D.				 Thread BSP	A mm	B mm	 W mm
	DN	Inch	Size	mm				
3AF82-2-4B	6	1/4	-4	6,3	1/8x28	34	15	17
3AF82-4-4B	6	1/4	-4	6,3	1/4x19	39	20	19
3AF82-4-4C	6	1/4	-4	6,3	1/4x19	39	20	19
3AF82-4-6B	10	3/8	-6	9,5	1/4x19	43	20	19
3AF82-6-6B	10	3/8	-6	9,5	3/8x19	46	23	22
3AF82-6-8B	12	1/2	-8	12,7	3/8x19	49	22	22
3AF82-8-8B	12	1/2	-8	12,7	1/2x14	53	26	27
3AF82-8-10B	16	5/8	-10	15,9	1/2x14	63	26	27

Material: Brass (B)
C: Material: Stainless Steel

Information about standard products or non-standard products can be found in the current price list.
Dimensions shown may be changed at any time without prior notice.





NM – Male BSP Parallel Pipe – L Series – Rigid – Straight – ED-Seal

ISO 1179



Approved fitting series for hose types:

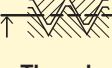

XXXX.XX.XX Part Number 	 Hose I.D.				 Thread BSP	A mm	B mm	 W mm
	DN	Inch	Size	mm				
3NM82-6-8B	12	1/2	-8	12,7	3/8x19	52	26	22
3NM82-8-8B	12	1/2	-8	12,7	1/2x14	55	28	27
3NM82-12-12B	20	3/4	-12	19,1	3/4x14	65	28	32

Material: Brass (B)

Hose fittings are delivered with ozone resistant Nitrile (NBR) O-Ring as a standard version. Working temperature from -30 °C up to +105 °C. Hose fittings with special O-Rings (Viton or EPDM) available on request. For O-ring dimensions and part-numbers see Section Eb.

Information about standard products or non-standard products can be found in the current price list. Dimensions shown may be changed at any time without prior notice.

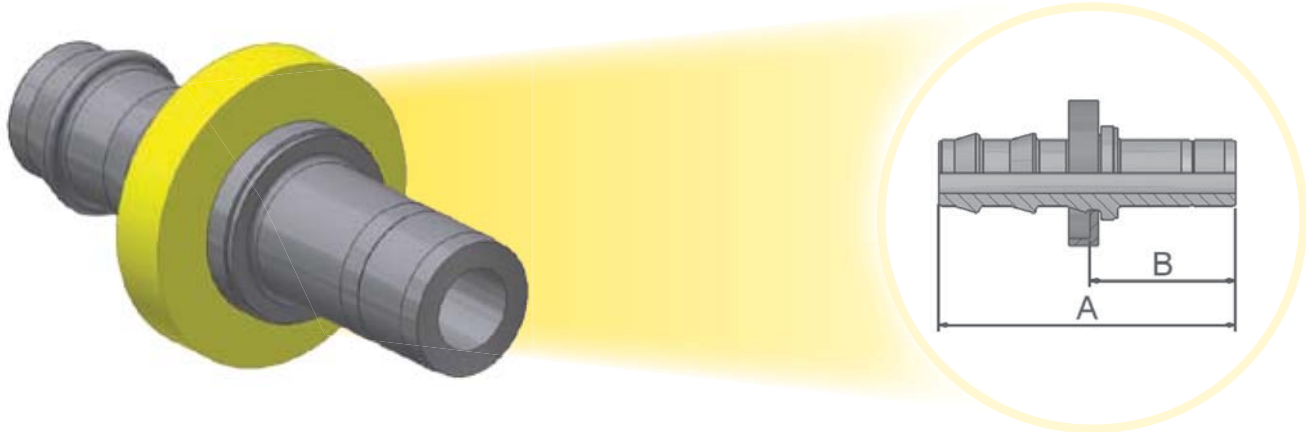

YW – Male Standpipe – Rigid – Straight – A-Lok

Metric Size Tube O.D. with Vee Notch



Approved fitting series for hose types:



XXXX.XX.XX Part Number 	 Hose I.D.				A mm	B mm
	DN	Inch	Size	mm		
3YW82-6-4C-ROUND	6	1/4	-4	6,3	39	20
3YW82-8-4C-ROUND	6	1/4	-4	6,3	40	21
3YW82-10-6C-ROUND	10	3/8	-6	9,5	44	22
3YW82-12-8C-ROUND	12	1/2	-8	12,7	54	27
3YW82-18-10C-ROUND	16	5/8	-10	15,9	65	29

Material: Stainless Steel



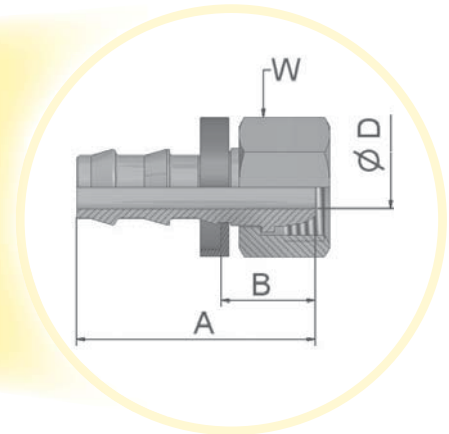

Information about standard products or non-standard products can be found in the current price list.
Dimensions shown may be changed at any time without prior notice.

VW121 – BSP Swivel Female (VW-Norm 39-V-16631)



Approved fitting series for hose types:

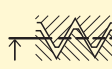

XXXX.XX.XX Part Number 	 Hose I.D.				 Thread BSP	A	B	D	 W
	DN	Inch	Size	mm					
VW121-8937*	6	1/4	-4	6,3	1/4x19	32	13	5	17
VW121-8938**	10	3/8	-6	9,5	3/8x19	38	15	7,5	19
VW121-8939**	14	1/2	-8	12,7	1/2x14	46	19	11	27
VW121-8940**	16	5/8	-10	15,9	3/4x14	58	21	14	32
VW121-8941**	20	3/4	-12	19,0	1x11	53	16	17	41

*stainless steel nipple, steel nut
**brass nipple, steel nut

Information about standard products or non-standard products can be found in the current price list.
Dimensions shown may be changed at any time without prior notice.

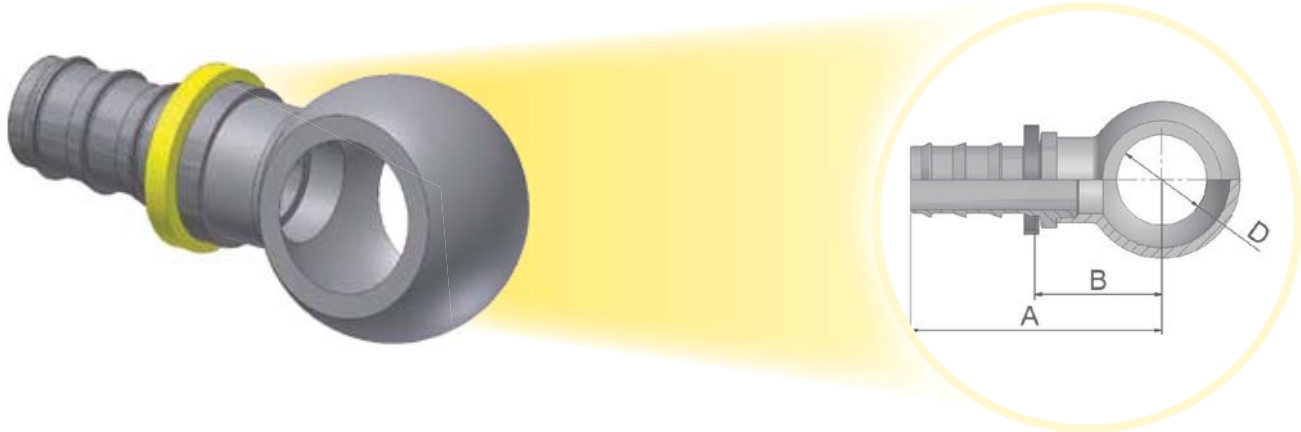

49 – Metric Banjo – Straight

DIN 7642



Approved fitting series for hose types:



XXXX.XX.XX Part Number 	 Hose I.D.				D mm	A mm	B mm
	DN	Inch	Size	mm			
34982-8-4	6	1/4	-4	6,3	8	36	17
34982-10-4	6	1/4	-4	6,3	10	38	19
34982-12-4	6	1/4	-4	6,3	12	40	21
34982-14-4	6	1/4	-4	6,3	14	42	23
34982-14-4C	6	1/4	-4	6,3	14	42	23
34982-10-6	10	3/8	-6	9,5	10	42	19
34982-12-6	10	3/8	-6	9,5	12	44	21
34982-14-6	10	3/8	-6	9,5	14	47	24
34982-14-6C	10	3/8	-6	9,5	14	47	24
34982-16-6	10	3/8	-6	9,5	16	49	26
34982-17-6	10	3/8	-6	9,5	17	49	26
34982-17-6C	10	3/8	-6	9,5	17	49	26
34982-14-8	12	1/2	-8	12,7	14	51	25
34982-18-8	12	1/2	-8	12,7	18	55	28
34982-22-8	12	1/2	-8	12,7	22	58	31
34982-22-10	16	5/8	-10	15,9	22	68	32
34982-26-12	20	3/4	-12	19,1	26	73	37

Material: Steel, zinc plated
C: Material: Stainless Steel

Information about standard products or non-standard products can be found in the current price list.
Dimensions shown may be changed at any time without prior notice.