

**Technical Description**

The design of the Tema System 100 allows the check of static and dynamic pressures as well as vacuum. With the integrated self-venting device (as standard), it is easy to evacuate any inclusions. This guarantees an accurate display of the measured value, especially with dynamic pressures. The measuring plugs are available with various connection options. They have very small dimensions and can be fitted very easily to the equipment. Thanks to the design and choice of materials, the plugs are maintenance-free. The measuring device with the pressure gauge is fitted with a Tema quick connect coupling. This guarantees coupling to the

measuring plugs in a matter of seconds. With the shut-off device in the plug and in the body of the coupling, the Tema System 100 allows a dry break, during coupling as well as during uncoupling. For measuring at a distance, a flexible extension cable is available; this can be coupled between the measuring plug and the measuring system. Thanks to its wide range of connections, the Tema System 100 is a versatile and flexible measuring system.

Maximum Working Pressure

Measuring plug 120: 400 bar
Other parts: 600 bar

Complete Hydraulic Set**System 100**

	Description	Part Number
<p>The Tema System 100 Complete Set is delivered in a plastic case and contains the following parts:</p> <p>1 piece measuring handle 101-2 and pressure gauge of your choice*</p> <p>1 piece measuring plug 120</p> <p>1 piece measuring cable 130, length 2,5 m, complete</p> <p>1 piece adapter 135, G 1/4" i. x G 1/8" o.</p> <p>1 piece adapter 136, G 1/8" i. x G 1/4" o.</p> <p>In the measuring case there is additional room for two further pressure gauges as well as an adapter 139. If two pressure gauges are required, the part number is, for example, 107-08 (Complete Set with one pressure gauge 0-250 bar and one pressure gauge 0-400 bar).</p> <p>* If measuring handle 101-21A is required instead of 101-2, this must be added to the order.</p>	Complete set not including pressure gauge	101
	Complete set with 1 pressure gauge -1 to +1,5 bar	104
	Complete set with 1 pressure gauge 0 to +25 bar	112
	Complete set with 1 pressure gauge 0 to +60 bar	114-QC
	Complete set with 1 pressure gauge 0 to +250 bar	107-QC
	Complete set with 1 pressure gauge 0 to +400 bar	108
	Complete set with 1 pressure gauge 0 to +600 bar	109-QC

Measuring Plugs

Technical Description

Thanks to their advanced design, the measuring plugs are reliable components in our measuring device. Made of hardened steel. The measuring plugs are maintenance free and are designed for temperatures from -40°C up to +110°C. The integrated valve seals up to a 90% vacuum. All mechanical parts in the measuring plug are made of corrosion resistant materials. Two different type of sealing (see picture on the right side). Available with two different types of covering cap.

- Fully sealed
- Maintenance-free
- Metal-to-metal seal

A Type of seal



B Type of seal



Maximum Working Pressure

Measuring plug 120: 400 bar
Other parts: 600 bar



Measuring Plugs

System 100

Connec-tion A	Description	Type of seal	L mm	L1 mm	HEX mm	Weight gr.	Part Number
G 1/8	with plastic cap	A	29	7,5	15	20	120
G 1/8	with metal cap	A	29	7,5	15	20	120-126
G 1/4	with plastic cap	A	36	11	18	35	121-125
G 1/4	with metal cap	A	36	11	18	35	121-126
G 1/4	with plastic cap	B	36	11	18	35	122-125
G 1/4	with metal cap	B	36	11	18	35	122-126
M 12 x 1,5	with plastic cap	A	36	11	18	35	123-125
M 12 x 1,5	with metal cap	A	36	11	18	35	123-126
M 10 x 1	with plastic cap	A	29	7,5	15	40	128-125
M 10 x 1	with metal cap	A	29	7,5	15	40	128-126

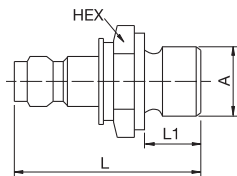

Measuring Plug Accessories

System 100

Description	Part Number
Plastic cap made of soft PVC	125-QC
Metal cap with O-ring seal. Quick-lock type coupling on plug. Extra safety. Up to 750 bar.	126K
Quick connect coupling for measuring plug with integrated shut-off valve. Seal made of FKM. G 1/8 male thread.	150
Adapter coupling female thread G 1/4"	150-137



Pressure Gauge/Measuring Handle/Self-Venting Block

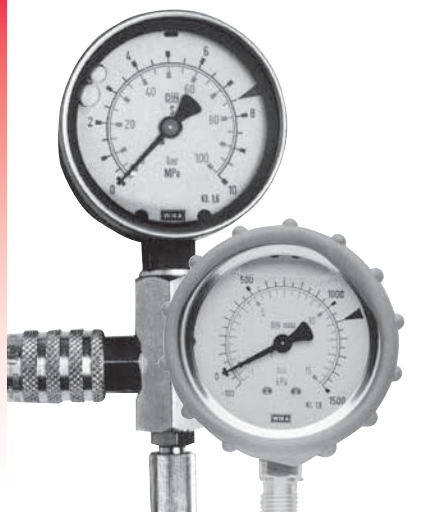

Pressure Gauge

- Filled with glycerine – suitable for temperatures to -40°C
- Special seal – quick change
- Measuring accuracy $\pm 1,6\%$
- Diameter 63 mm
- Pressure gauge connection G 1/4", male thread
- Scale with double graduation (MPa + bar)

Measuring Handle

Measuring handle 101-2 is used for low pressures up to max. 60 bar.

- System 100 – time-saving quick connect couplings
- Shut-off valve in coupling body and plug – dry break

Measuring handle 101-21A can be coupled even under full working pressure.

Self-Venting Block

In order to obtain exact measured values (particularly with dynamic pressure measurements), it is essential that there should be no air bubbles trapped between the measuring plug and the pressure gauge. This can be checked simply and effectively with the Tema 100 Measuring System, since the air bubbles can easily be removed. It is possible to vent the system at maximum working pressure by using the venting screw.

Pressure Gauge

System 100

	Description	Part Number
Dimension Pressure gauge + measuring handle: 	-1 to +1,5 bar	MAN 04
	0 to +6 bar	MAN 15
	0 to +25 bar	MAN 12
	0 to +60 bar	MAN 14
	0 to +250 bar	MAN 07
	0 to +400 bar	MAN 08
	0 to +600 bar	MAN 09
	Rubber guard for pressure gauge	100-40

Measuring Handle/Self-Venting Block

System 100

	Description	Part Number
Measuring handle	Measuring handle	101-2
	Measuring handle can be coupled under pressure	101-21A
Alternative position for the venting screw ISO-G 1/8 ISO-G 1/4	Self-venting block	101-3-QC

High-Pressure Hoses

Technical Description

Tema high-pressure hose – produced for measurements and mini-hydraulic systems. Exact selection of materials and production under strict control contribute to the satisfaction and reliable safety of the product. Max. working pressure 630 bar.

Material

Inner and outer hose: high-quality POLYAMIDE
Pressure carrier: KEVLAR

Caution: If the hoses are to be used for compressed air, this must be mentioned in the order.

Advantages

- Remains flexible, even under full working pressure, thanks to its small external dimensions and a suitable choice of materials.
- Resistant to all mineral and most synthetic oils
- Resistant to ageing
- No increase in volume (no differences in measurements)
- Temperature range from -40°C up to +100°C

In order to achieve optimal durability, the hoses can be strengthened with a spring at each end. Add-on code "F" after the itemnumber of each connection.



Ordering example for a complete high-pressure hose

	B	C	D
200K PA hose	1,6 Total- length m	210F G 1/8" Female thread + spring	240 Pressure gauge connect. G 1/4"

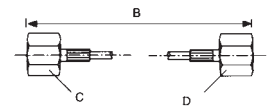

Pressures





Type	Work. Pressure	Burst Pressure	Inner Dimens.	Outer Dimens.
200K	630 bar	2000 bar	2,0 mm	4,9 mm

Temperature range from -40°C to +93°C.

Connections

System 100 High-Pressure Hoses

Caution! The hoses are produced in various lengths
Please specify hose and/or total length incl. connecting fittings. Design subject to alterations.

	Description	DN	Part Number
	G 1/8" female thread	2	210-QC
	G 1/8" male thread	2	220
	Pressure gauge connection G 1/4" female thread	2	240
	M 16 x 2,0 female thread for measuring plug		270

Measuring Cable

System 100

	Description	Part Number
Measuring cables in other designs and lengths on request.		
	Measuring cable for coupling the measuring handle 101-2 to measuring plugs.	130
	Supplied as standard with measuring plug (120) and coupling (150): 2,5 m.	

Accessories

System 100

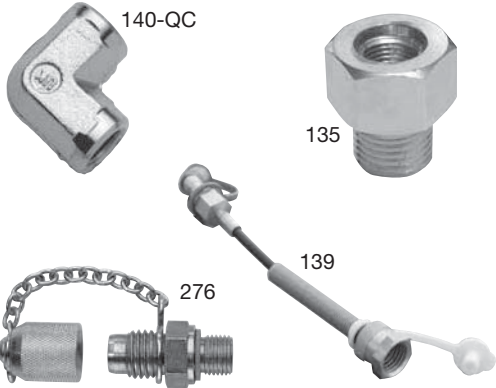
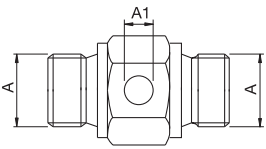
	Thread	Description	Part Number
	G 1/4 i. x G 1/8 o.	Adapter (female x male)	135
	G 1/8 i. x G 1/4 o.	Adapter (female x male)	136
	G 1/8 i. x G 1/4 i.	Adapter (female x female)	137
	M 16	Changeover adapter for measuring plug	139
	G 1/8 i. x G 1/8 i.	Angle 90° (female x female)	140-QC
		Plastic case (without picture)	101-1
	M 16 x 2 / G 1/4	Measuring plug	276
	M 16 x 2 / G 3/8	Measuring plug	277
	A: G 1/4; A1: G 1/8	Double plug with connecting thread for measuring plug	DNT2-1



PJS Series



Technical Description

The PJ/PJS series was specially developed for hydraulic diagnosis. Using the PJS system, oil quality and oil pressure can be determined by extracting oil directly from the plug. The components are produced in steel, galvanised in the connection and conform to norm SAE J 1502.

The PJS plug can be used both to test the oil and to extract oil.

Advantages

The FlatFace design makes it easier to clean out dirt. Optimised oil intervals save time, labour and operating capital. The easy-grip, knurled locking sleeve makes coupling and uncoupling easy. Sampling also in working pressure circuits.

Working Pressure

See information below.

Working Temperature

-30°C up to +100°C (NBR)

Material Coupling

Coupling Body	Steel, zinc plated, passivated, sealed
Sleeve	Steel, zinc plated, passivated, sealed
Valve	Steel/brass
Spring	AISI 301
Locking Balls	AISI 420 C
Seals	NBR

Material Plug

Plug Body	Steel, zinc plated, passivated, sealed
Valve	Steel, zinc plated, passivated, sealed
Spring	AISI 301
Seals	NBR

Applications Area



Couplings

PJS-Series

Connection A	Description	HEX mm	L mm	L1 mm	D mm	Working Press. bar	Part Number
<p>Female Thread</p>	1/8"-27 NPT	24	53	8	27	415	SJ18FN
	1/8"-27 NPT	24	53	8	27	415	SJS18FN
	1/4"-18 NPT	24	53	12	27	415	SJ14FN
	1/4"-18 NPT	24	53	12	27	415	SJS14FN

Plugs

PJS-Series

Connection A	Description	HEX mm	L mm	L1 mm	D mm	Working Press. bar	Part Number
	9/16"-18 UNF	11/16"	43	10		415	PJ916U
	9/16"-18 UNF	11/16"	43	10		415	PJS916U

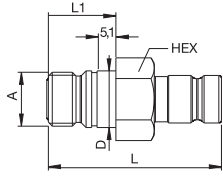

Male Thread Bulkhead Mounting

Connection A	Description	HEX	L mm	L1 mm	D mm	Working Press. bar	Part Number
9/16"-18 UNF	for Diagnostic	11/16"	46	18	15	415	PJ916FQ



Technical Description

Diagnostic couplings provide easily accessible test points for performance testing of hydraulic and pneumatic systems. Easily incorporated into original equipment or retrofitted to existing circuits, PD plugs meet or exceed SEA J 1502 and ISO 15171-1 design and performance specification.

Advantages

- Carbon steel for couplers. High tensile steel for plugs.
- For water applications also available in brass on request.
- Ball locking mechanism.

- Flush-faced poppet valve for a minimal air inclusion when connecting, minimal fluid loss during disconnection and for an easy cleaning.
- The sealing and locking groove are induction hardened to resist mechanical abuse and brinelling, whilst avoiding toughness.
- A safety sleeve lock prevents accidental disconnection.
- Push-to-connect operation allows single handed operation when connecting the coupling.

Applications

- Industrial equipment
- Mobile equipment
- Agricultural equipment

Working Pressure

max. 420 bar

Working Temperature

-40°C up to +110°C (NBR) depending on the medium. Special seals are available on request (see page 6).

Material Coupling

Body	Steel
Sleeve	Steel
Valve	Steel
Valve Sleeve	Steel
Springs	Steel
Seals	Nitrile
Back-up Rings	PTFE
Valve Body	Steel

Material Plug

Body	Steel
Seals	Nitrile
Valve	Steel
Spring	Steel
Retainer	Steel

Options:

1. For some end configurations, test points are also available in brass and stainless steel AISI 316.
2. Other metric end configurations are available on request.
3. Possibility to have test point connectable under pressure up to 420 bar.

Please contact your Parker team.

Flow Capacity with Oil with Viscosity of 43cSt at 38°C as per ISO 7241/2-2000

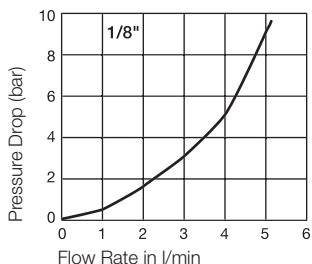

Couplings

PD-Series

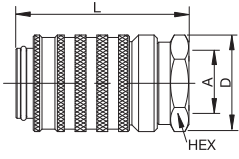
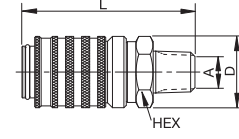
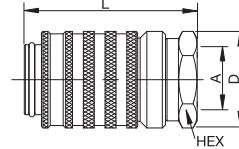
	Body Size	Connection A	Tube Size	Hex	L mm	L1 mm	D mm	Weight gr.	Part number	
 <p>Female NPTF Thread – SAE J 476</p>	1/8"	1/8"-27		13/16"	42,4		24,4	90	PD222	
	1/8"	1/4"-18		13/16"	53,8		24,4	113	PD242	
 <p>Male NPTF Thread – SAE J 476</p>	1/8"	1/4"-18		13/16"	57,4		24,4	104	PD243	
 <p>Female UNF Thread – SAE J 1926</p>	1/8"	9/16"-18		13/16"	53,8		24,4	109	PD260	

Plugs

PD-Series

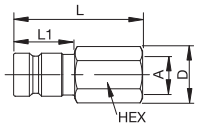
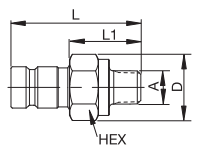
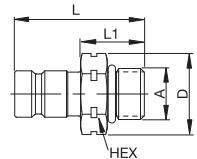
	Body Size	Connection A	Tube Size	Hex	L mm	L1 mm	D mm	Weight gr.	Part number	
 <p>Female NPTF Thread – SAE J 476</p>	1/8"	1/8"-27		9/16"	37,6	19,8	16,5	27	PD322	
	1/8"	1/4"-18		3/4"	41,4	23,6	21,9	54	PD342	
 <p>Male NPTF Thread – SAE J 476</p>	1/8"	1/8"-27		11/16"	39,4	21,6	20,1	77	PD323	
	1/8"	1/4"-18		11/16"	37,6	19,8	20,1	27	PD343	
	1/8"	3/8"-18		13/16"	38,1	20,3	23,8	40	PD363	
 <p>Male Metric Thread to ISO 6149</p>	1/8"	M 14 x 1,5		17 mm	35,0	17,3	19,6	32	PD367-1A	

Plugs

PD-Series

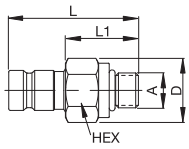
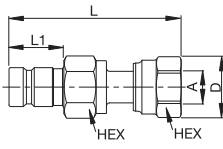
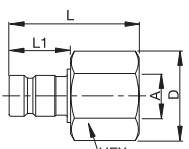
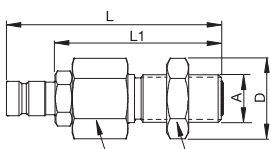
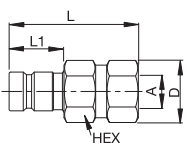
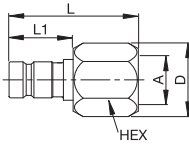
	Body Size	Connec- tion A	Tube Size	Hex	L mm	L1 mm	D mm	Weight gr.	Part number
 <p>Male UNF Thread - SAE 1926</p>	1/8"	7/16"-20		11/16"	40,6	22,9	20,1	36	PD341
	1/8"	1/2"-20		5/8"	33,5	15,7	18,3	22	PD351 *
	1/8"	9/16"-18		11/16"	33,5	15,7	20,1	27	PD361 *
 <p>O-Lok SAE J 1453 / ISO 8434-3</p>	1/8"	9/16"-18	1/4" (6 mm)	11/16"	55,4	17,8	20,1	54	PD34BTL
	1/8"	1 1/16"-16	3/8" (10 mm)	13/16"	58,4	17,8	23,9	63	PD36BTL
 <p>O-Lok SAE J 1453 / ISO 8434-3</p>	1/8"	13/16"-16	1/2" (12 mm)	1 5/16"	28,4	17,8	38,4	58	PD38BTL *
 <p>Bulkhead O-Lok SAE J 1453 / ISO 8434-3</p>	1/8"	9/16"-18	1/4" (6 mm)	13/16"	75,7	57,9	23,8	86	PD346 *
 <p>Triple-Lok SAE J 514 - ISO 8434-2</p>	1/8"	9/16"-18	3/8" (10 mm)	11/16"	42,2	17,8	20,1	40	PD36BTX *
 <p>Triple-Lok SAE J 514 - ISO 8434-2</p>	1/8"	1 1/16"-12	3/4" (20 mm)	1 1/4"	35,3	17,8	36,5	122	PD312BTX

* Add 6 to part number to include the dust cap.

Body Size	Version	Part number
1/8"	for plug	PD6-285

Other materials (EPDM/FKM/HNBR) are available on request.